



1.Introduction:

It is an 76.0MHz-108.0MHz Wireless FM Radio Receiver DIY Kit with Rechargeable 18650 Lithium Battery. It has a built-in high-definition display LCD display screen which can clearly display the receiving frequency and it can store radio stations, which is enough to meet your needs.

2.Feature:

- 1>.HD display LCD display screen
- 2>.Support storage of 22 radio stations
- 3>.Automatically search for radio stations
- 4>.Built-in 30-level digital volume adjustment
- 5>.Automatic memory function after power off
- 6>.Support 76Hz-108MHz receiver frequency
- 7>.Built-in 5W power amplifier
- 8>.Rechargeable 18650 Lithium Battery
- 9>.Power saving mode with backlight off for 20 seconds
- 10>.Support speaker and earphone audio output

3.Parameter:

- 1>.Work Voltage:DC 3.0V-5.0V
- 2>.Output impedance:8ohm
- 3>.Output power:5W
- 4>.Response frequency:50Hz-18KHz
- 5>.Output channel:Mono for speaker and Dual channel for earphone
- 6>.Frequency:87.0MHz~108.0MHz(Disable Campus Broadcasting Band)
- 7>.Frequency:76.0MHz~108.0MHz(Enable Campus Broadcasting Band)
- 8>.Equivalent noise: >=30dB
- 9>.Work Temperature:-40℃~85℃
- 10>.Work Humidity:5%~95%RH
- 11>.Size(Installed):114*97*31mm

4.Use Methods:

- 1>.Press power switch to turn ON/OFF work voltage.
- 2>.Keep press AUTO button to automatically search and store FM radio stations that can be listened to.
- 3>.Short press(click) AUTO button to turn ON/OFF mute function.
- 4>.Automatically name searchable stations like P01,P02,P02 and so on.
- 5>.Press P+ and P- to switch saved FM stations.
- 6>.Press SP+ and SP- to adjust volume from V00 to V30.
- 7>.Switch Campus Broadcasting Band: Keep press SP+ and SP- before power ON and then turn ON work power switch. It means enable Campus Broadcasting Band if display C1 on LCD. It means disable Campus Broadcasting Band if display C0 on LCD.Available after restart.
- 8>.Enable backlight mode: Keep press P+ and P- before power ON and then turn ON work power switch. It means keep backlight ON if display B1 on LCD. It means the backlight will turn OFF after 20second if display B0 on LCD(This is the power saving mode).Available after restart.
- 9>.It can output audio from speaker and earphone jack. The speaker of the module does not work when the earphone is connected.
- 10>.Charging: Red LED indicator.
- 11>.Charged: Blue LED indicator.
- 12>.Note: FM radio cannot be played when charging.

5.Component Listing:

NO.	Component Name	PCB Marker	Parameter	QTY
1	Electrolytic Capacitor	C1	10uF	1
2	Monolithic Capacitor	C2	0.1uF 104	1
3	DuPont Female Socket	FM	15Pin	1
4	3.5mm AUX Audio Socket	AUDIO		1
5	75ohm FM Antenna	ANT		1
6	Lithium Battery Charging Module			1
7	Micro USB Socket	DC5V		1
8	Metal Film Resistor	R1	39Kohm	1
9	Metal Film Resistor	R2,R3	10Kohm	2
10	Black Button	SP+/SP-/P+/P-/AUTO	6*6*20mm	5
11	Black Button Cap	SP+/SP-/P+/P-/AUTO	Green	5
12	Self-locking Button	S6	8*8mm	1
13	Self-locking Button Cap	S6	Random Color	1
14	LM4863 Power Amplifier	U1	SOP-16	1
15	FM Receiver Module	FM	15Pin	1
16	18650 Lithium Battery		4.2V	1
17	18650 Lithium Battery Box	BAT+,BAT-		1
18	2Pin Wire	SP	7cm	1
19	Speaker	SP		1
20	Micro USB Power Wire		100cm	1
21	Acrylic Board			6
22	M3*12mm Copper Pillar			3
23	M3*6mm Screw			21
24	M3 Nut			15
25	M2*10mm Screw			1
26	M2 Nut			1
27	PCB			1

Note:Users can complete the installation according to the PCB silk screen and component list.

6.Schematic Diagram:

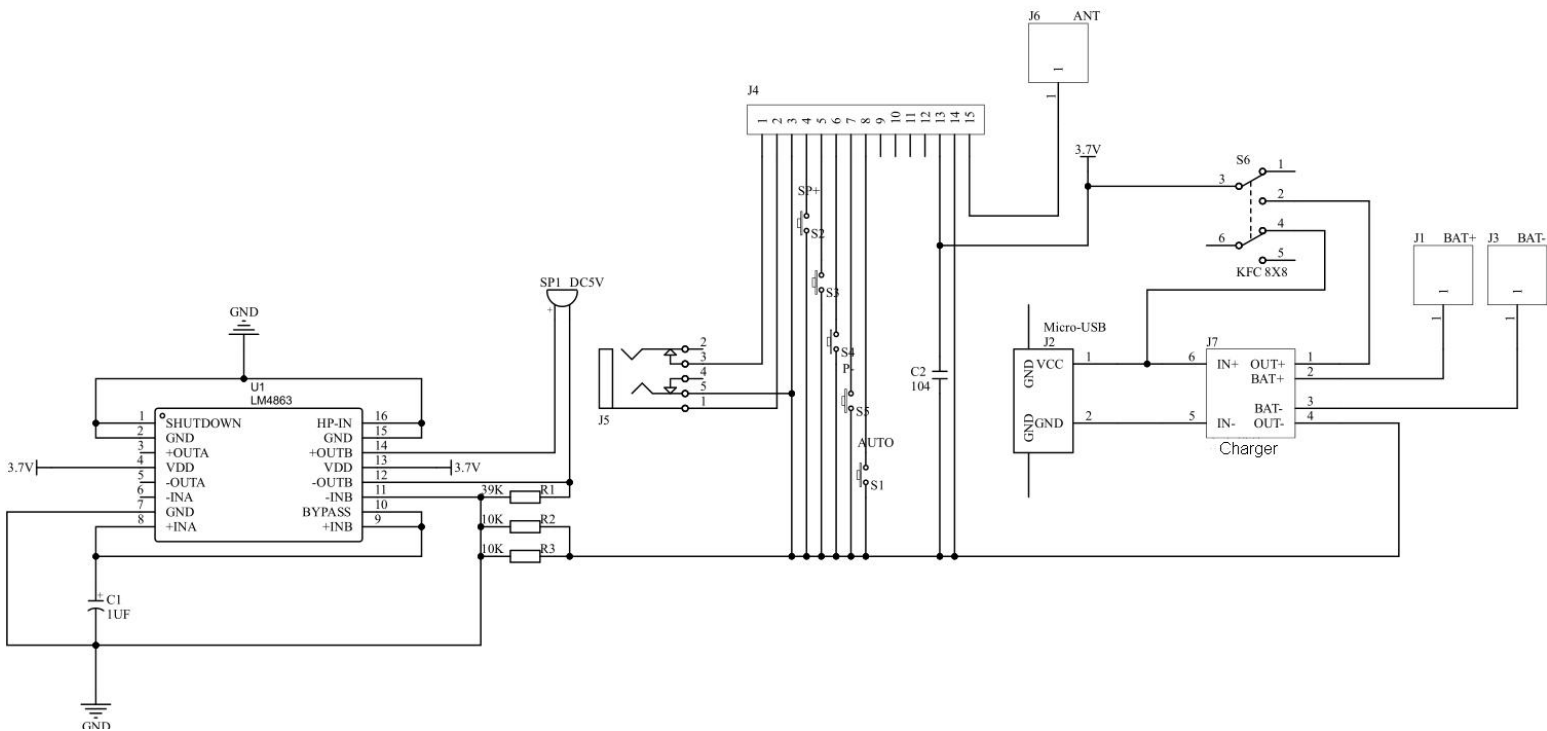

7. Installation Tips:

- 1>.User needs to prepare the welding tool at first.
 - 1.1>.Soldering iron (<50 Watt)
 - 1.2>.Rosin core ("radio") solder
 - 1.3>.Wire cutters
 - 1.4>.Wire strippers
 - 1.5>.Screwdriver
- 2>.Please be patient until the installation is complete.
- 3>.The package is DIY kit.It need finish install by user.
- 4>.The soldering iron can't touch the components for a long time(1.0 second), otherwise it will damage the components.
- 5>.Pay attention to the positive and negative of the components.
- 6>.Strictly prohibit short circuit.
- 7>.User must install the LED according to the specified rules.Otherwise some LED will not light.
- 8>.Install complex components preferentially.
- 9>.Make sure all components are in right direction and right place.
- 10>.It is strongly recommended to read the installation manual before starting installation!!!
- 11>.Please wear anti-static gloves or anti-static wristbands when installing electronic components.

8. Installation Steps(Please be patient):

- 1>.Step 1: Install 1pcs SMD components SOP-16 LM4863 Power Amplifier at U1. Verify and confirm the installation direction of LM4863. The rectangular silk screen on the PCB coincides with the crystal oscillator on the LM4863 to locate the installation direction.
- 2>.Step 2: Randomly choose a pad on the PCB, and then melt the solder on this pad.
- 3>.Step 3: Fix LM4863: Use a soldering iron to melt tin on the pad just now and hold LM4863 with tweezers in the other hand to place/press on U1 to prevent movement. Take care to match and align each pads. Then remove soldering iron. Then remove tweezers after solder tin cooling and solidification.
- 4>.Step 4: Connect others pads on LM4863 to pads on PCB by tin and soldering iron.
- 5>.Step 5: Install 2pcs 10Kohm Metal Film Resistor at R2,R3.
- 6>.Step 6: Install 1pcs 39Kohm Metal Film Resistor at R1.
- 7>.Step 7: Install 1pcs 0.1uF 104 Monolithic Capacitor at C2.

- 8>.Step 8 Install 1pcs Lithium Battery Charging Module. Note:fill 6 through-holes with a large amount of solder tin after aligning the installation pads form two PCB.
- 9>.Step 9: Install 1pcs Micro USB Socket at DC5V.
- 10>.Step 10: Install 1pcs 3.5mm AUX Audio Socket at AUDIO.
- 11>.Step 11: Install 1pcs 10uF Electrolytic Capacitor at C1.Pay attention to distinguish between positive and negative.The Longer pin is positive pole. Note: Horizontal placement.
- 12>.Step 12: Cut a pin from 16Pin Female Socket.
- 13>.Step 13: Install DuPont Female Socket at FM.
- 14>.Step 14: Install 1pcs 8*8mm Self-locking Button at S6.
- 15>.Step 15: Install 5pcs 6*6*20mm Black Button at SP+/SP-/P+/P-/AUTO.
- 16>.Step 16: Connect 2Pin 7cm Wire to 4ohm 5W Speaker.
- 17>.Step 17: Fix 1pcs 75ohm FM Antenna at ANT by M2*10mm Screw and M2 Nut. And then fix with a large amount of solder tin. Note that the antenna is installed on the other side of the PCB.
- 18>.Step 18: Install 1pcs FM Audio Receiver on Female Socket. Pay attention to the direction of the cut pin.
- 19>.Step 19: Tear off the protective film on the surface of the acrylic shell.
- 20>.Step 20: Fix 3pcs M3*12mm Copper Pillar on PCB back side by 3pcs M3*6mm Screw.
- 21>.Step 21: Connect speaker to PCB at SP. The speaker does not distinguish between positive and negative.
- 22>.Step 22: Connect 18650 Lithium Battery Box to PCB at BAT+,BAT- pad. Red wire connect to 'BAT+' pad.
- 23>.Step 23: Test. Correctly install a rechargeable 18650 battery and test its functions by following 'Use Methods'.Pay attention to the positive and negative poles of the battery, otherwise it may damage the circuit board.
- 24>.Step 24: Fix PCB on acrylic board by 3pcs M3*6mm Screw.
- 25>.Step 25: Install another acrylic plate and note the antenna mounting hole and direction.
- 26>.Step 26: Install side acrylic plate for power socket and note the mounting hole and direction.
- 27>.Step 27: Install another side acrylic plate.
- 28>.Step 28: Remove battery and fix 18650 Lithium Battery Box on another side acrylic plate by M3*6mm Screw and M3 Nut.
- 29>.Step 29: Correctly install a rechargeable 18650 battery again.Pay attention to the positive and negative poles of the battery, otherwise it may damage the circuit board.
- 30>.Step 30: Install the battery acrylic plate.
- 31>.Step 31: Fix Speaker on the last acrylic plate by 4pcs M3*6mm Screw and 4pcs M3 Nut.
- 32>.Step 32: Install the last acrylic plate and fix it with speaker by 4pcs M3*6mm Screw.
- 33>.Step 33: Install button caps for black buttons and self-locking button.

9.Install shown steps:

Step 1: Install 1pcs SMD components SOP-16 LM4863 Power Amplifier at U1. Verify and confirm the installation direction of LM4863. The rectangular silk screen on the PCB coincides with the crystal oscillator on the LM4863 to locate the installation direction.

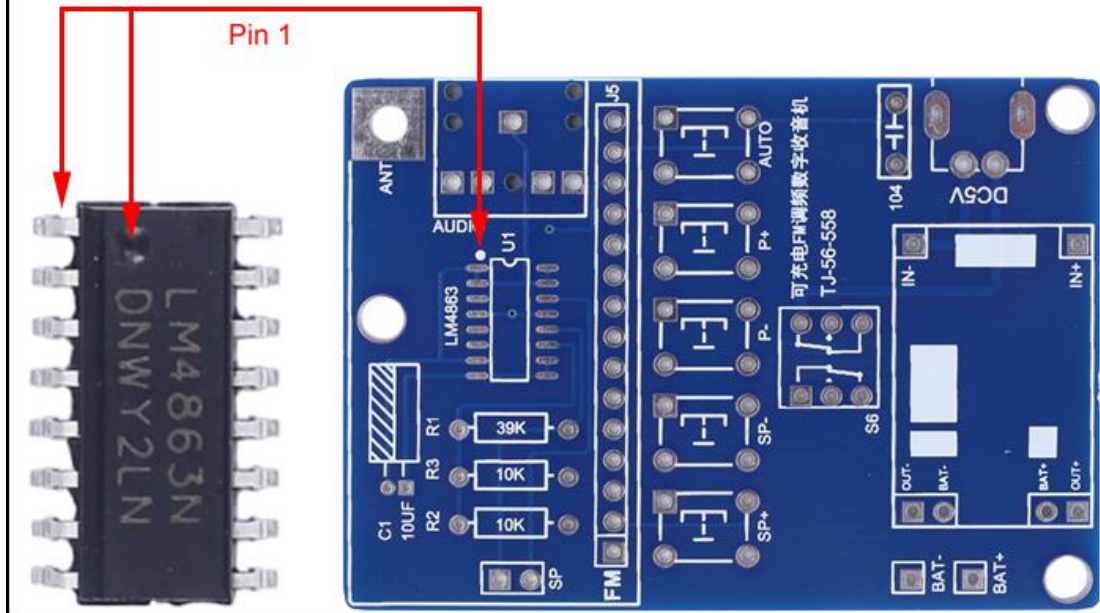

Step 2: Randomly choose a pad on the PCB, and then melt the solder on this pad.

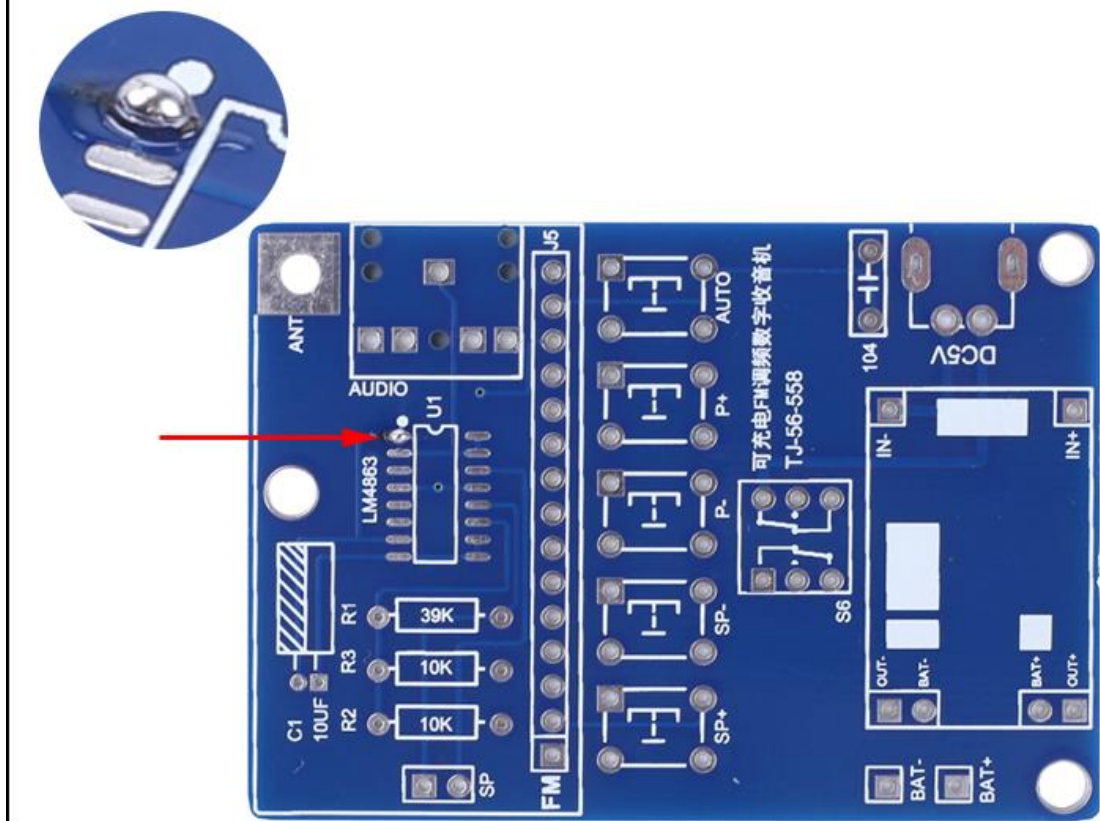

Step 3: Fix LM4863: Use a soldering iron to melt tin on the pad just now and hold LM4863 with tweezers in the other hand to place/press on U1 to prevent movement. Take care to match and align each pads. Then remove soldering iron. Then remove tweezers after solder tin cooling and solidification.

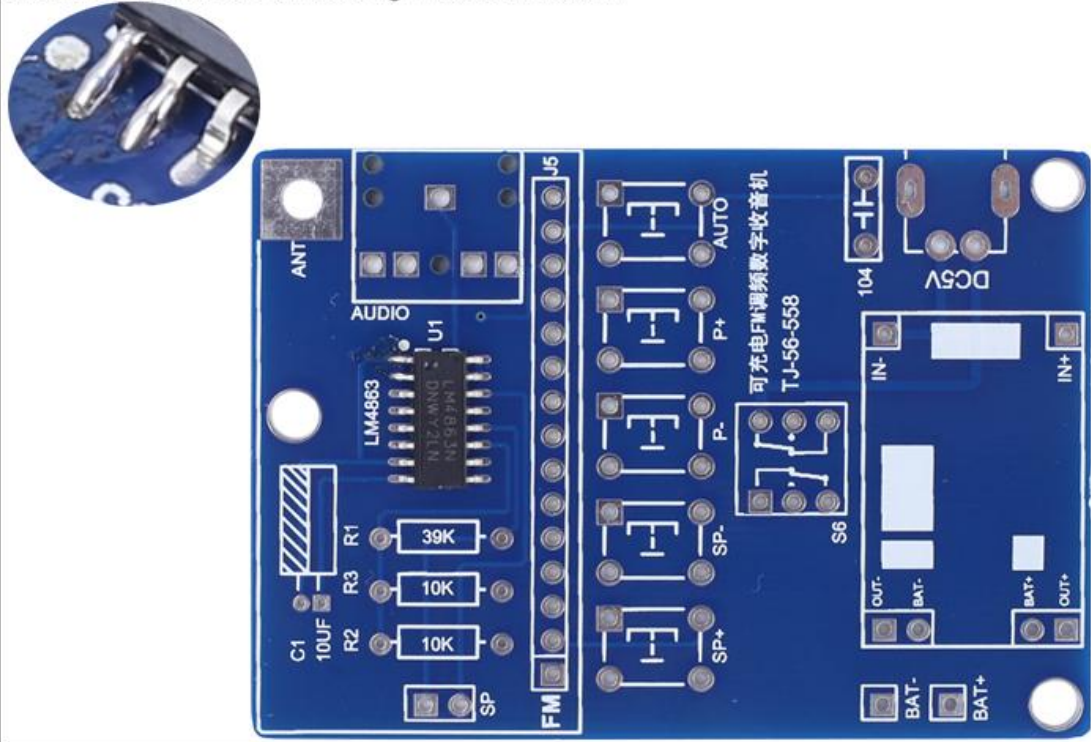

Step 4: Connect others pads on LM4863 to pads on PCB by tin and soldering iron.

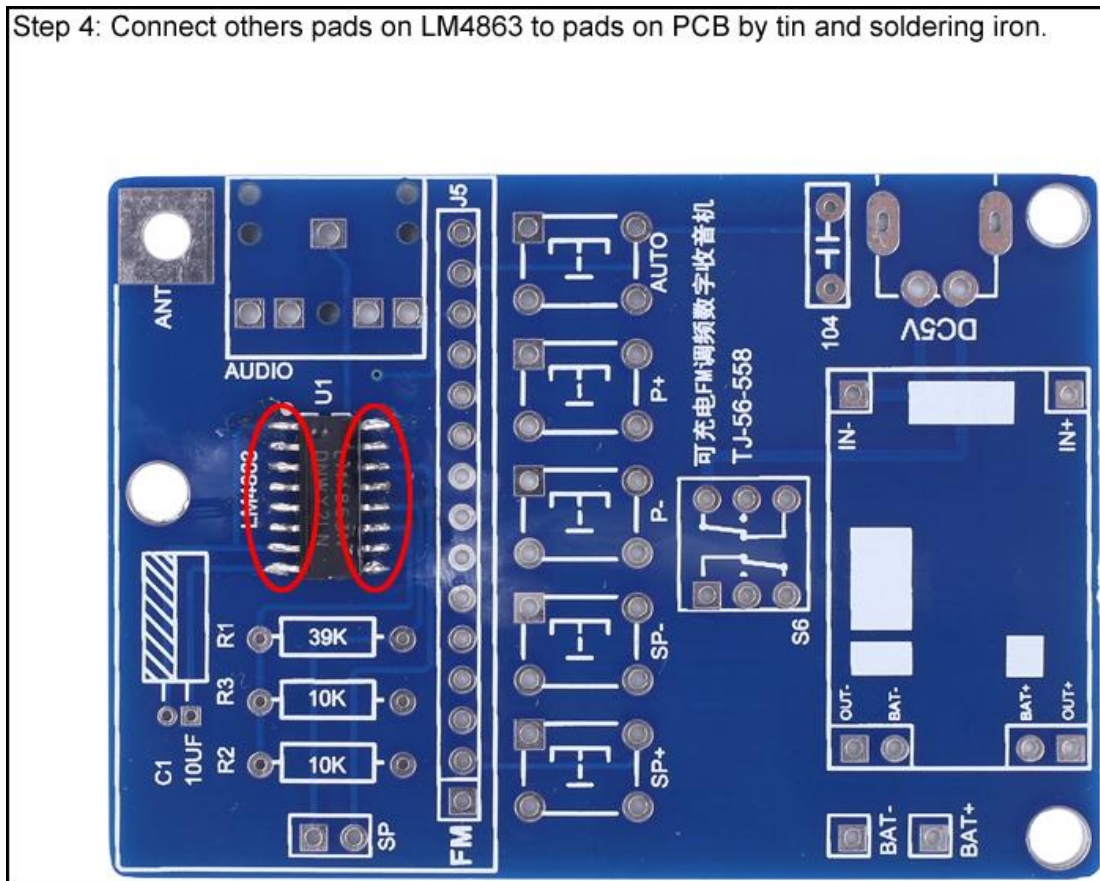

Step 5: Install 2pcs 10Kohm Metal Film Resistor at R2,R3.

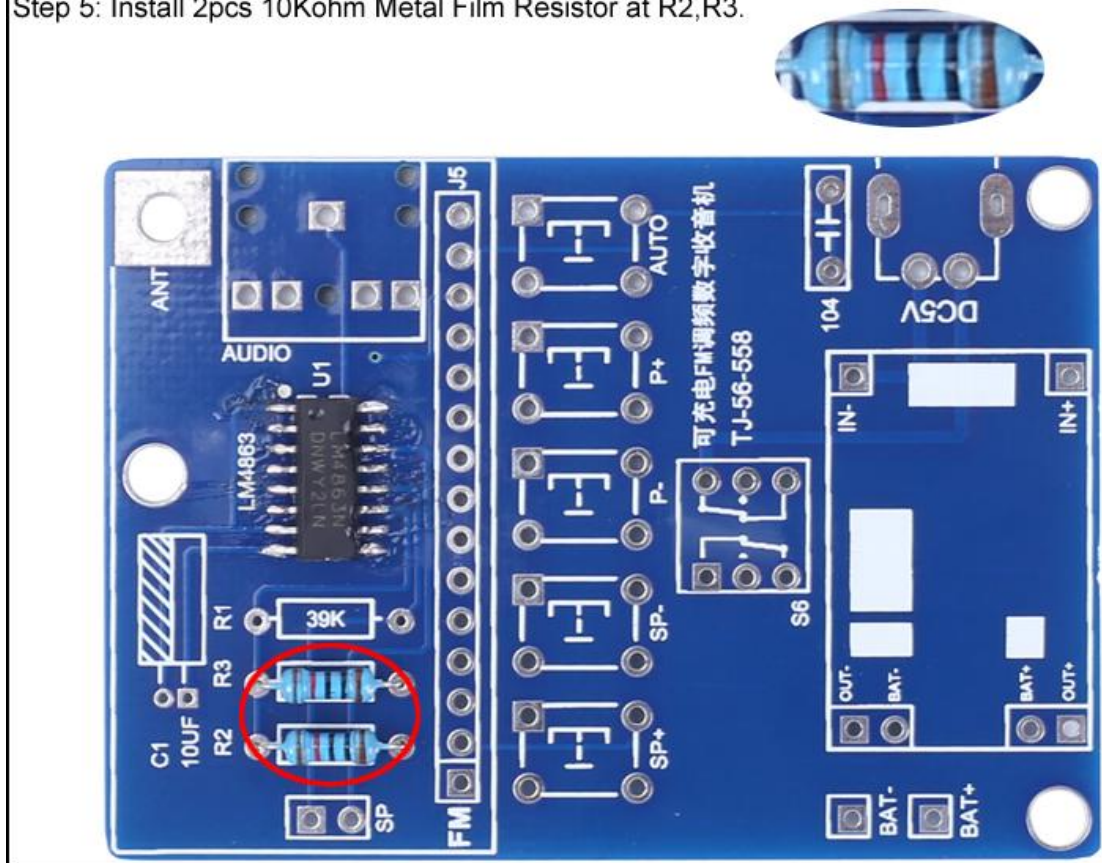

Step 6: Install 1pcs 39Kohm Metal Film Resistor at R1.

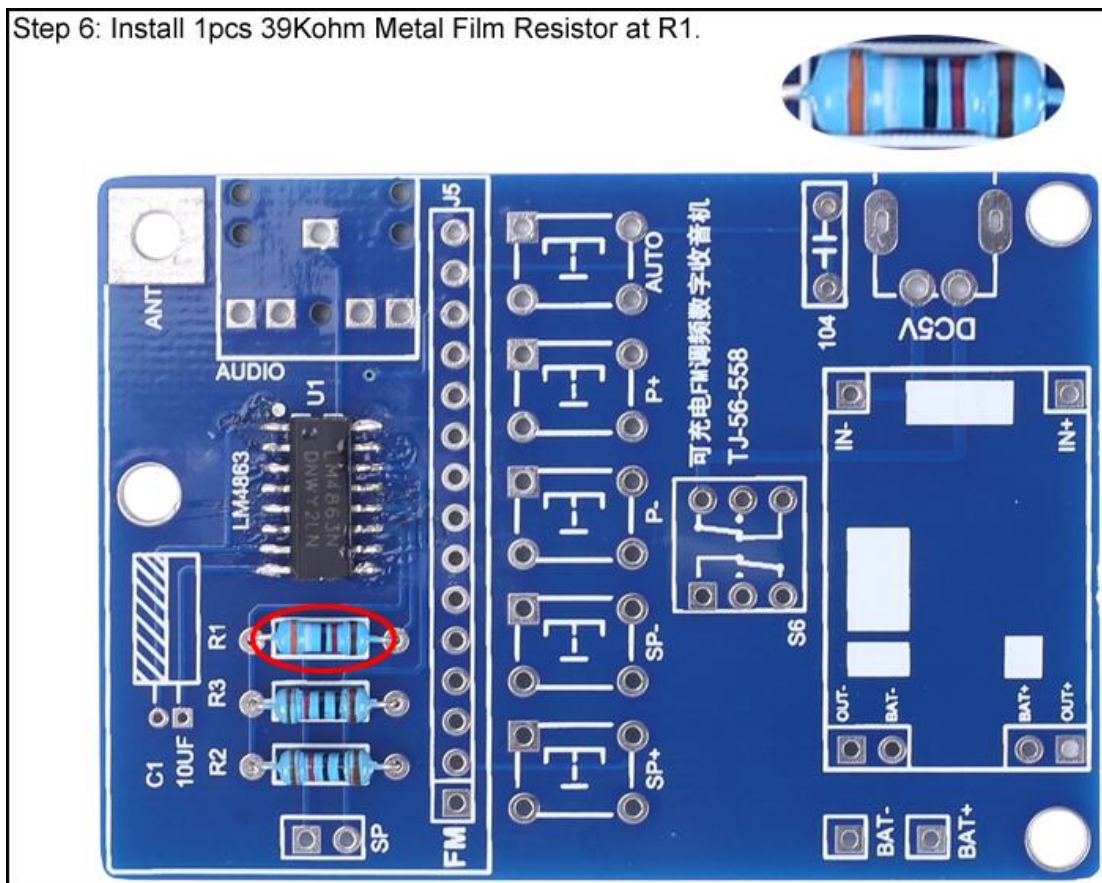

Step 7: Install 1pcs 0.1uF 104 Monolithic Capacitor at C2.

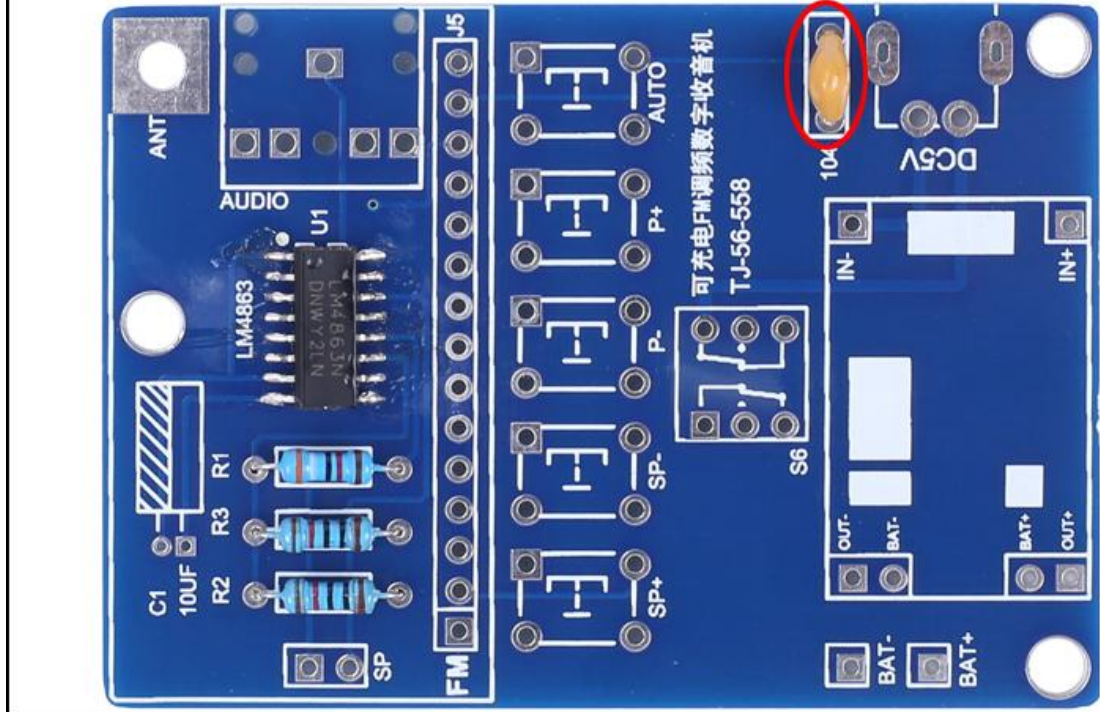

Step 8 Install 1pcs Lithium Battery Charging Module.

Note: fill 6 through-holes with a large amount of solder tin after aligning the installation pads form two PCB.

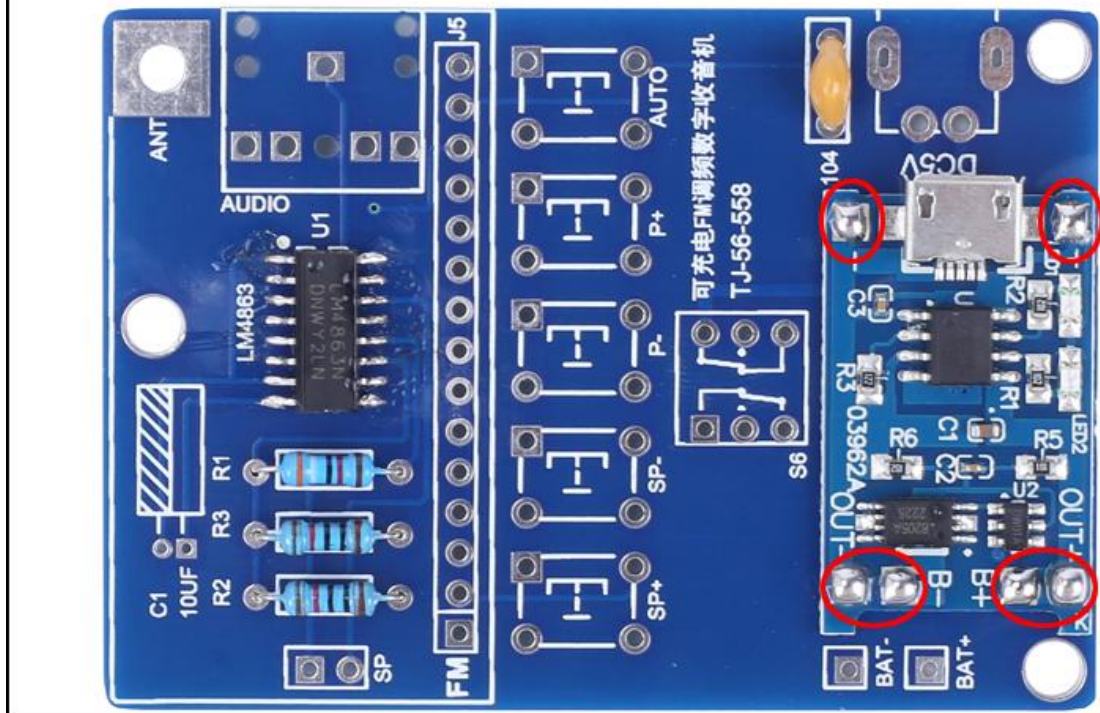

Step 9: Install 1pcs Micro USB Socket at DC5V.

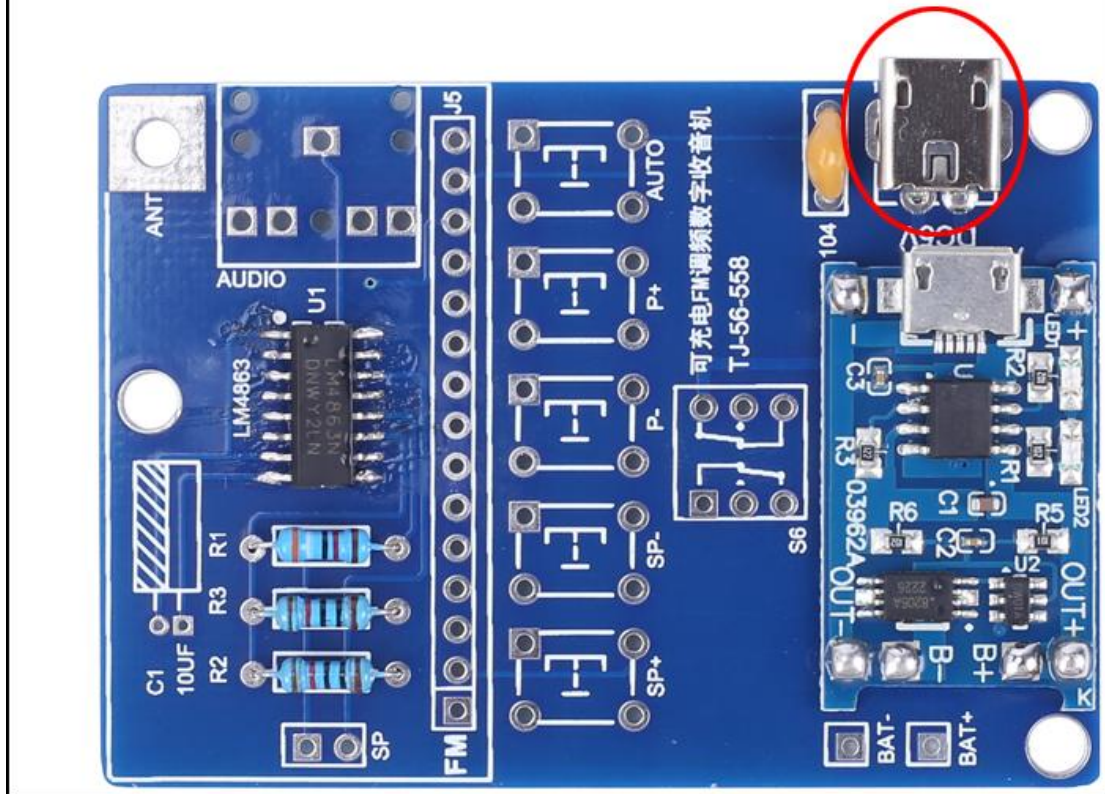

Step 10: Install 1pcs 3.5mm AUX Audio Socket at AUDIO.

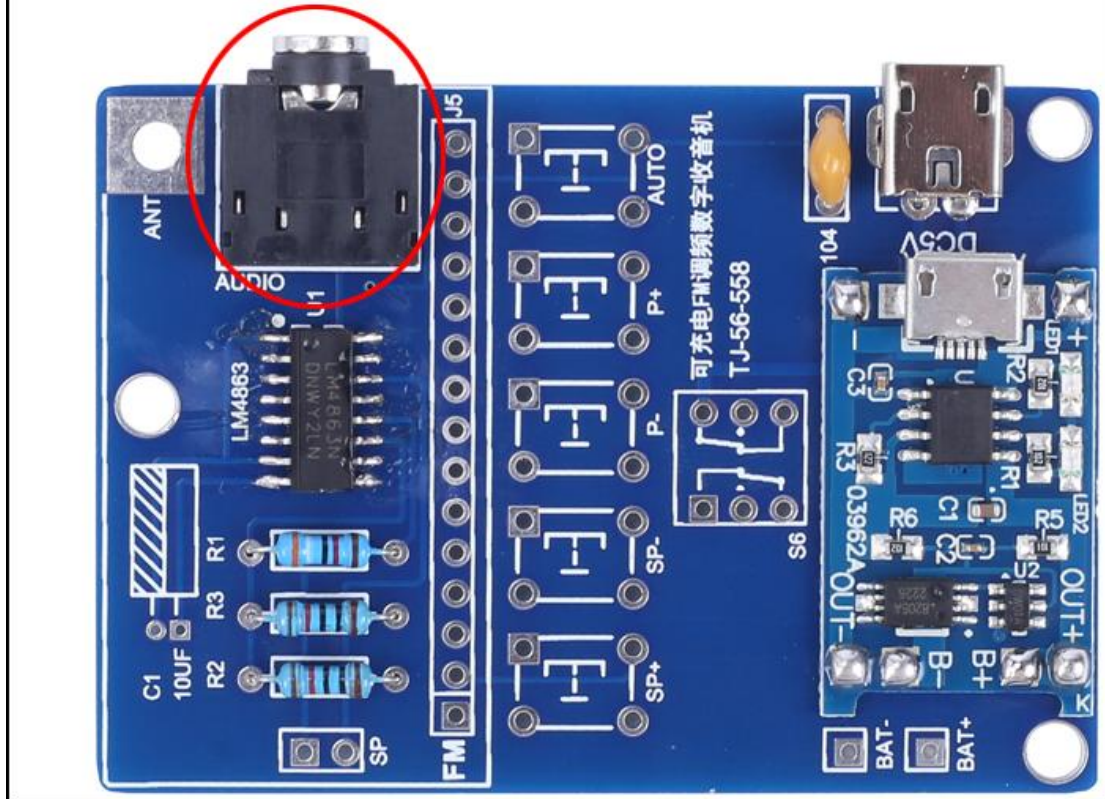

Step 11: Install 1pcs 10uF Electrolytic Capacitor at C1. Pay attention to distinguish between positive and negative. The Longer pin is positive pole.
Note: Horizontal placement.

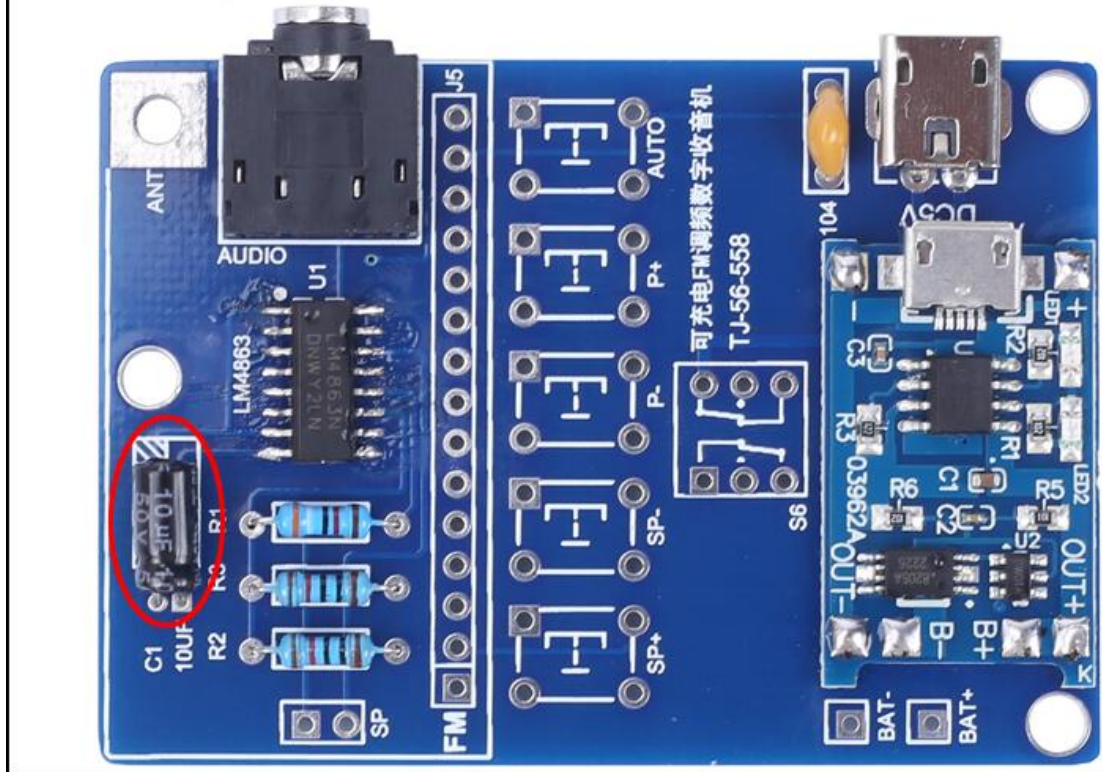

Step 12: Cut a pin from 16Pin Female Socket.

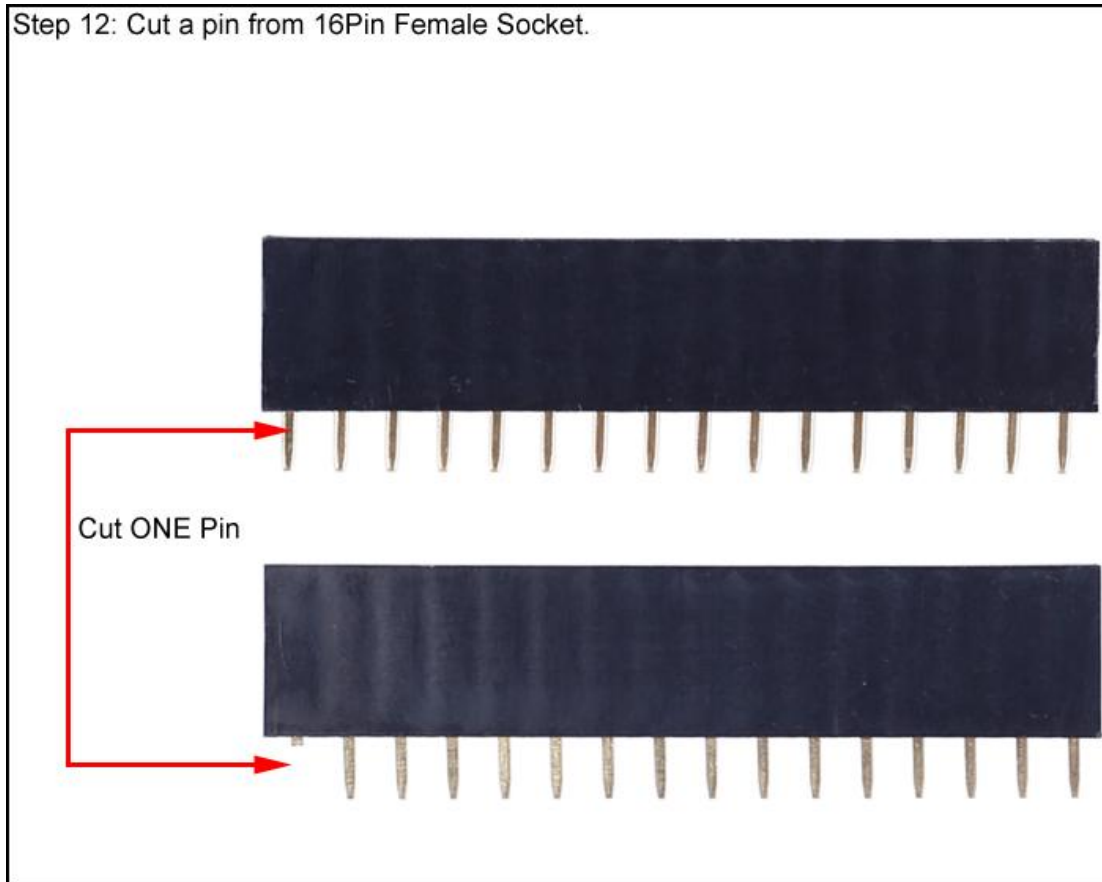

Step 13: Install DuPont Female Socket at FM.

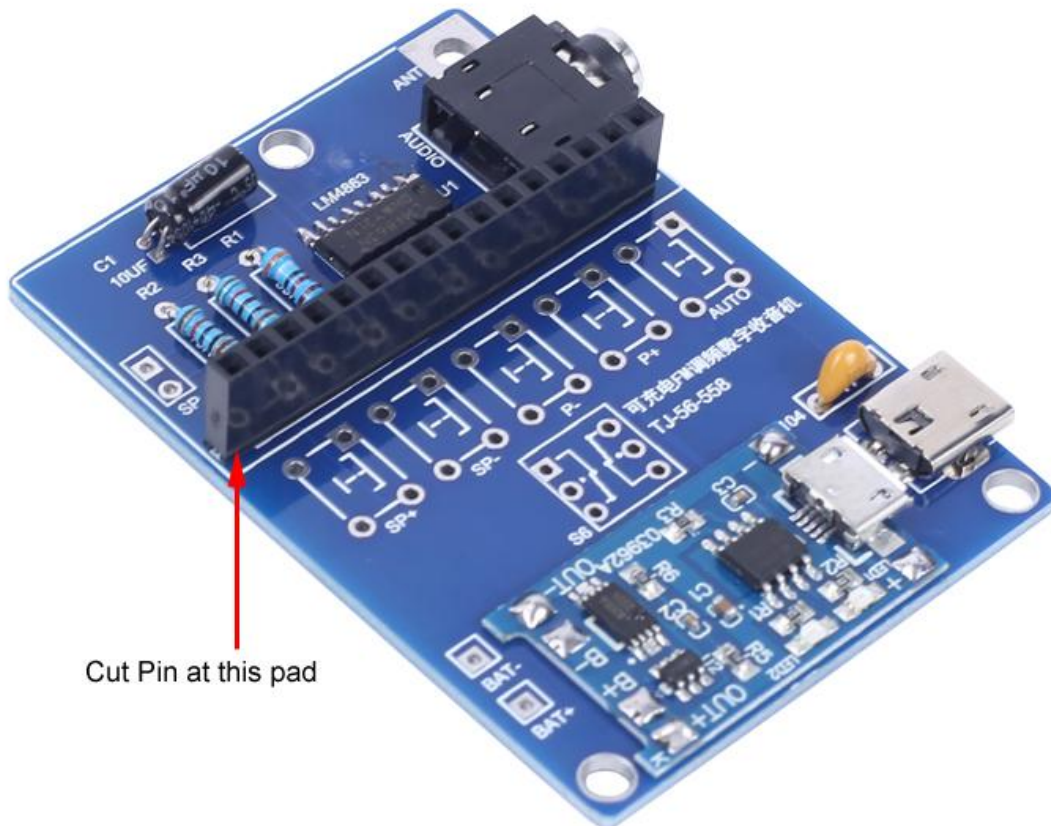

Step 14: Install 1pcs 8*8mm Self-locking Button at S6.

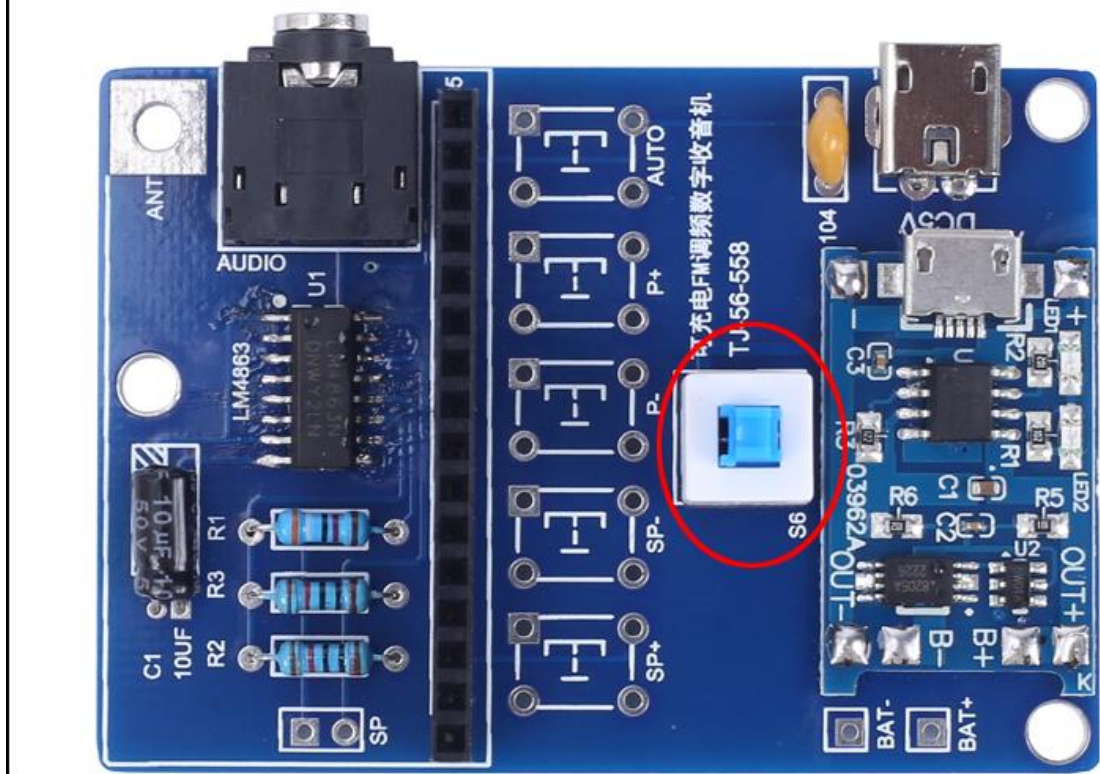

Step 15: Install 5pcs 6*6*20mm Black Button at SP+/SP-/P+/P-/AUTO.

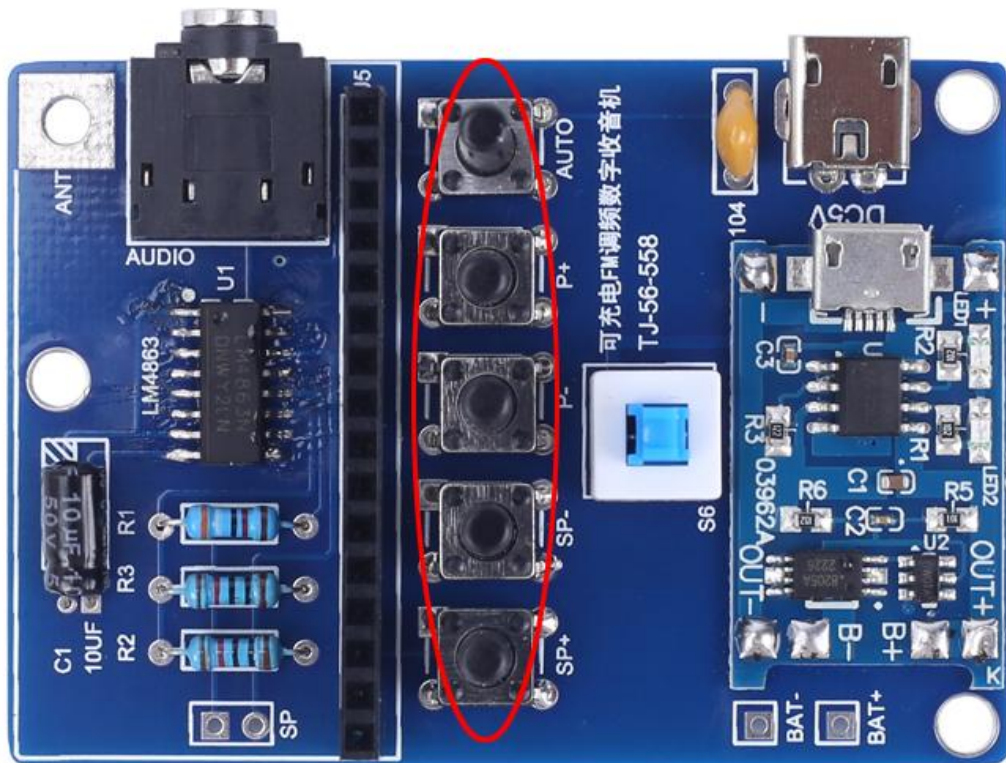

Step 16: Connect 2Pin 7cm Wire to 4ohm 5W Speaker.

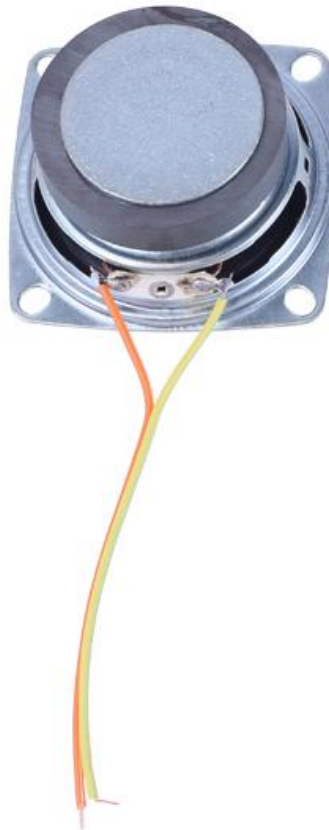

Step 17: Fix 1pcs 75ohm FM Antenna at ANT by M2*10mm Screw and M2 Nut. And then fix with a large amount of solder tin. Note that the antenna is installed on the other side of the PCB.

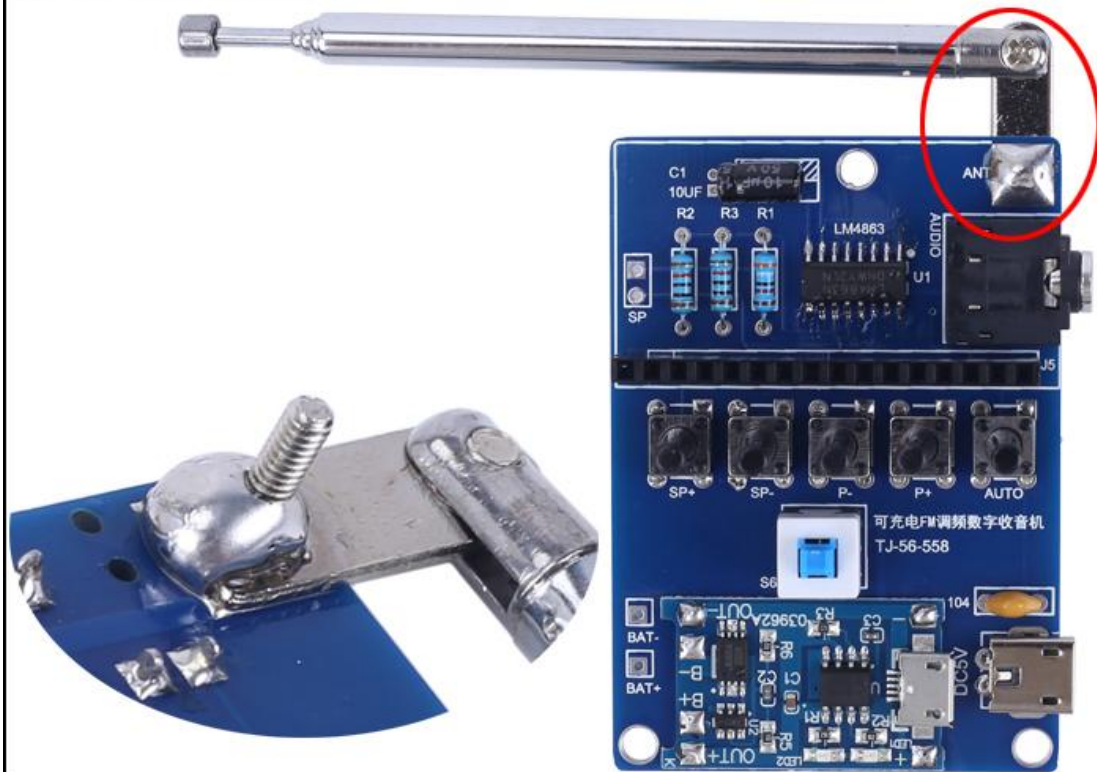

Step 18: Install 1pcs FM Audio Receiver on Female Socket. Pay attention to the direction of the cut pin.



Step 19: Tear off the protective film on the surface of the acrylic shell.



Step 20: Fix 3pcs M3*12mm Copper Pillar on PCB back side by 3pcs M3*6mm Screw.

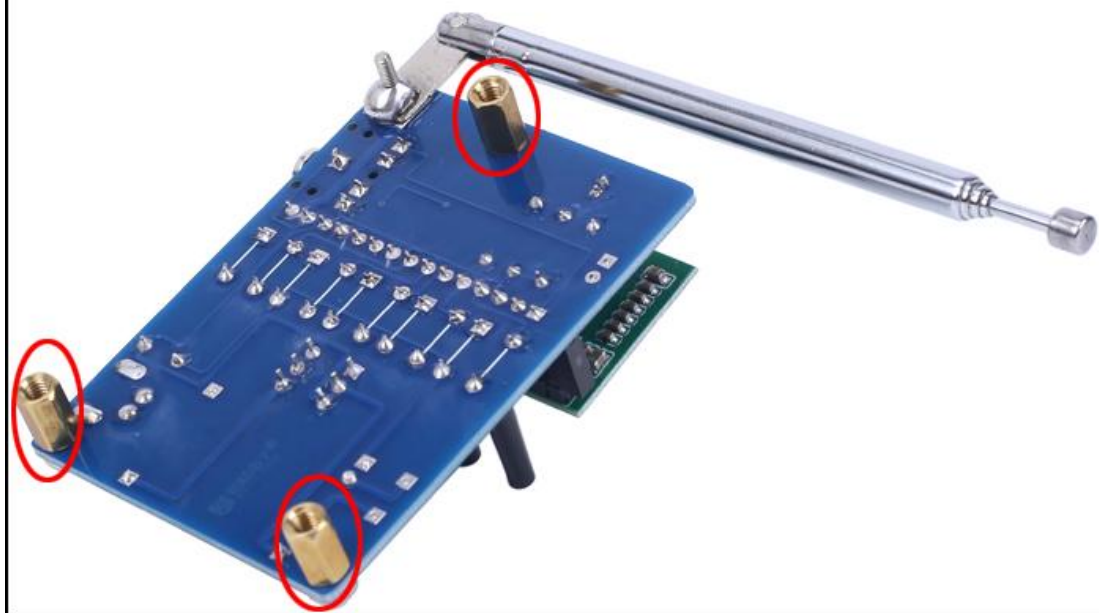

Step 21: Connect speaker to PCB at SP. The speaker does not distinguish between positive and negative.

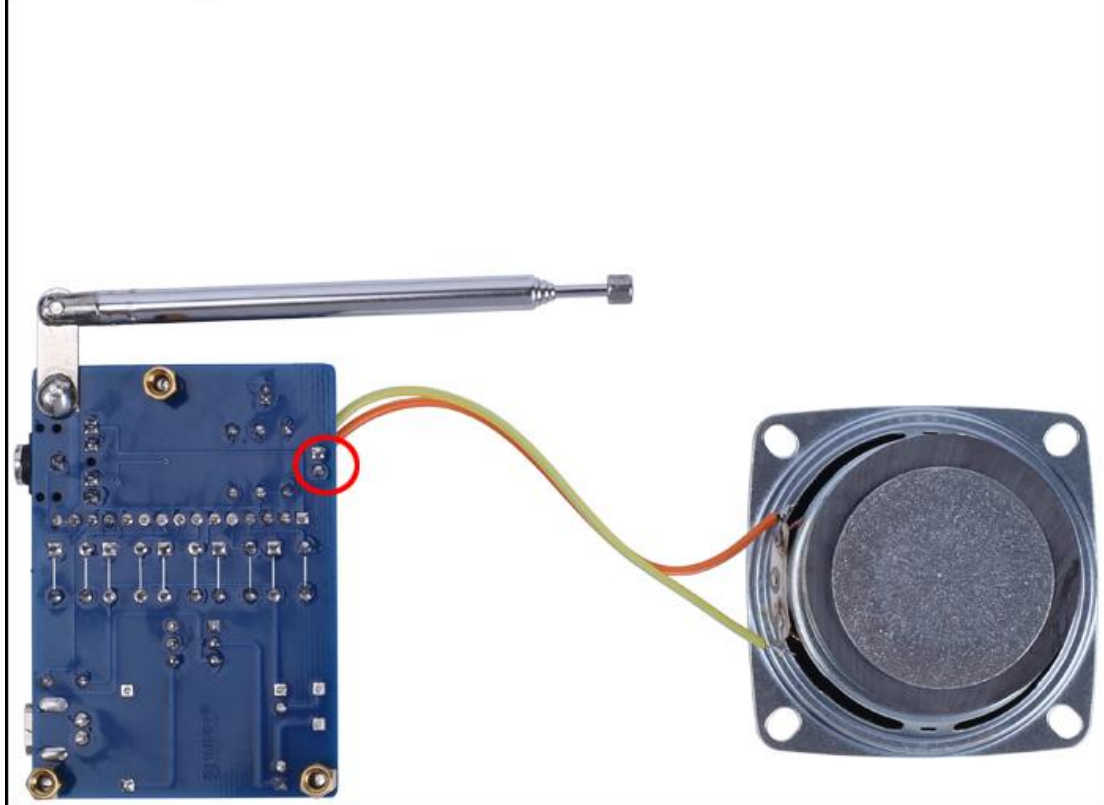

Step 22: Connect 18650 Lithium Battery Box to PCB at BAT+,BAT- pad. Red wire connect to 'BAT+' pad.

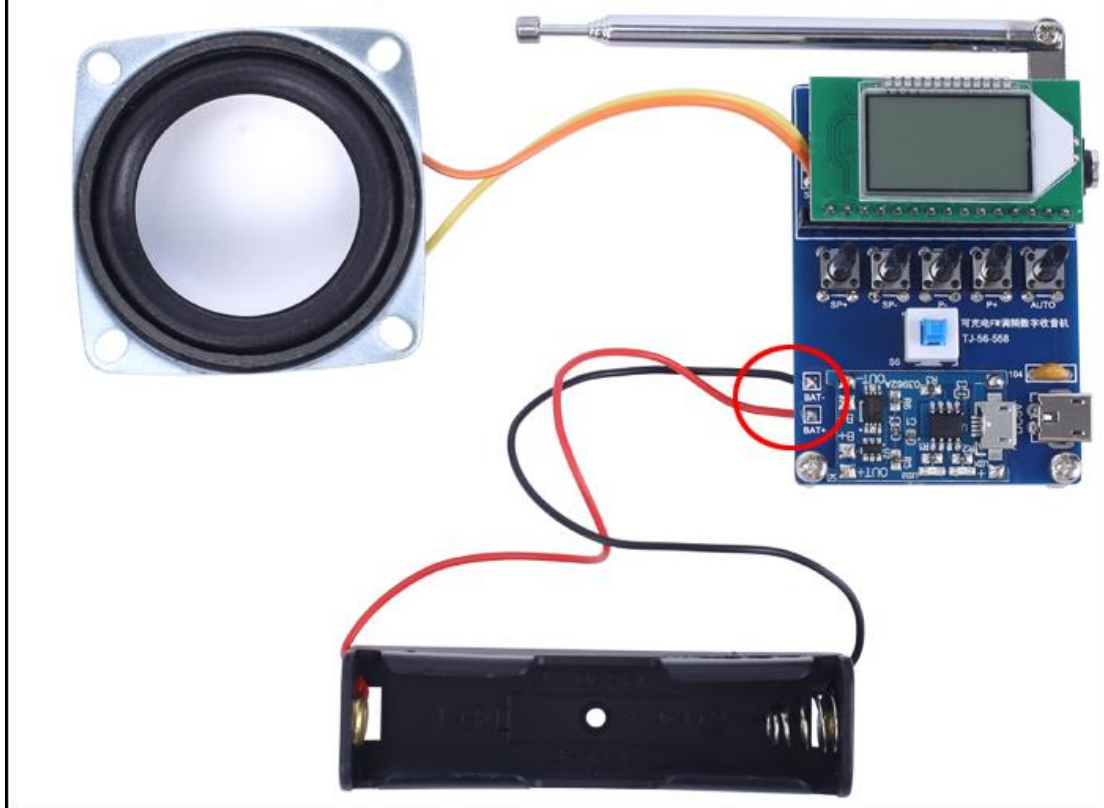

Step 23: Test. Correctly install a rechargeable 18650 battery and test its functions by following ' Use Methods '. Pay attention to the positive and negative poles of the battery otherwise it may damage the circuit board.

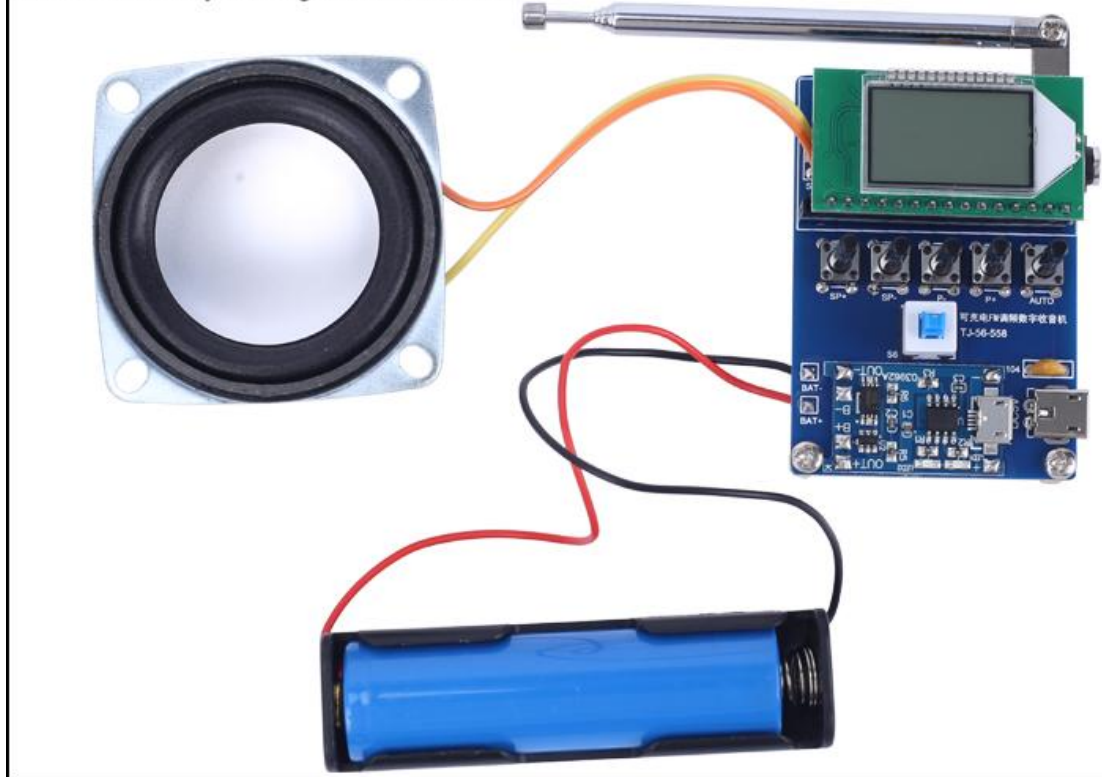

Step 24: Fix PCB on acrylic board by 3pcs M3*6mm Screw.

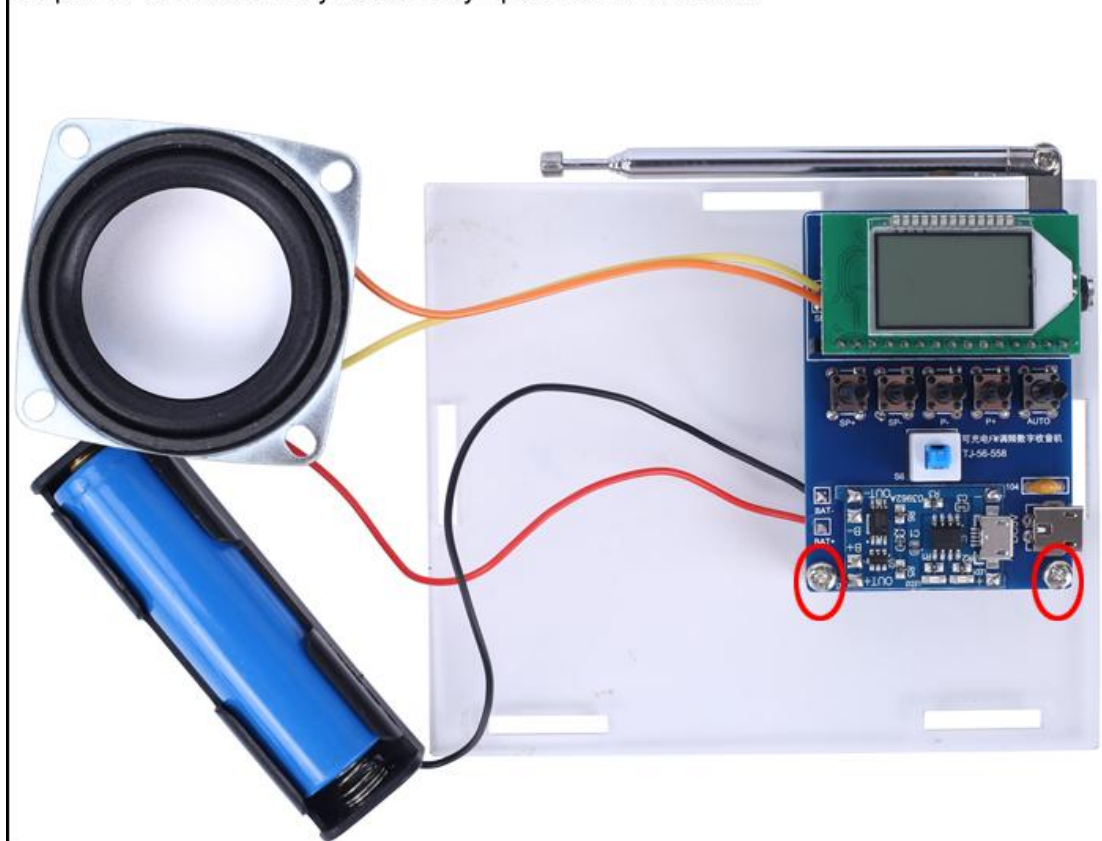

Step 25: Install another acrylic plate and note the antenna mounting hole and direction.

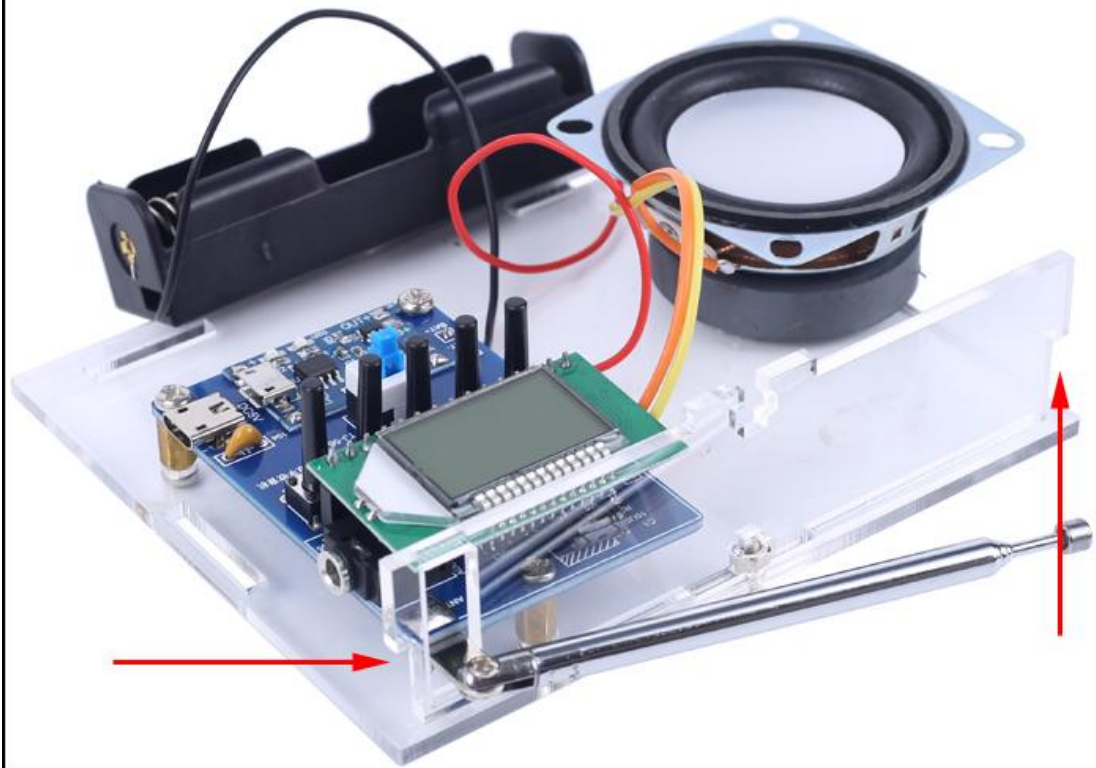

Step 26: Install side acrylic plate for power socket and note the mounting hole and direction.

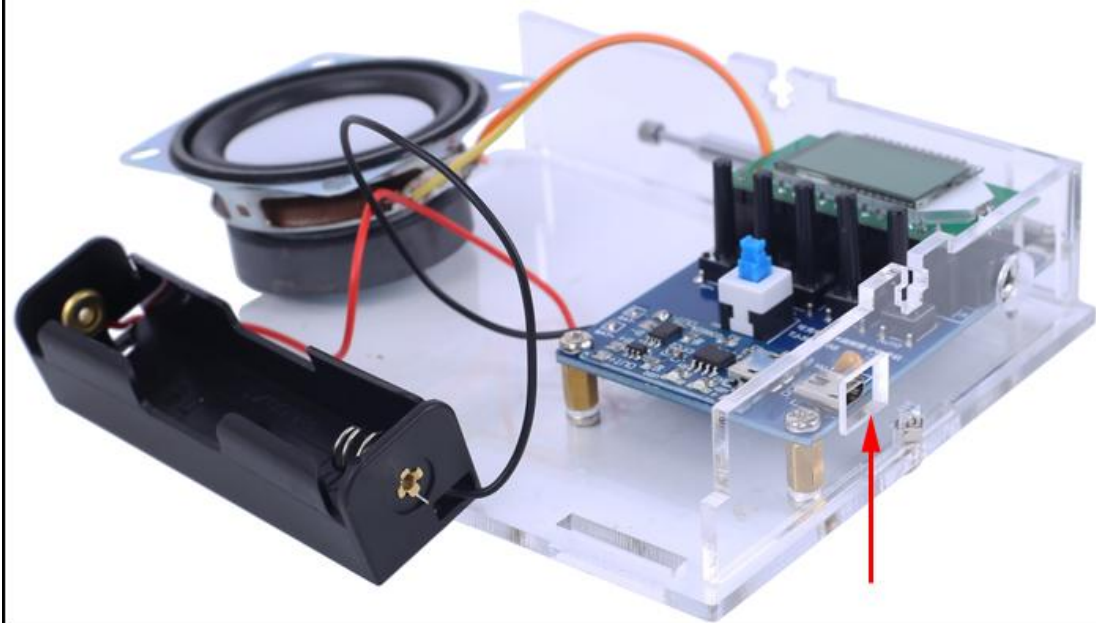

Step 27: Install another side acrylic plate.

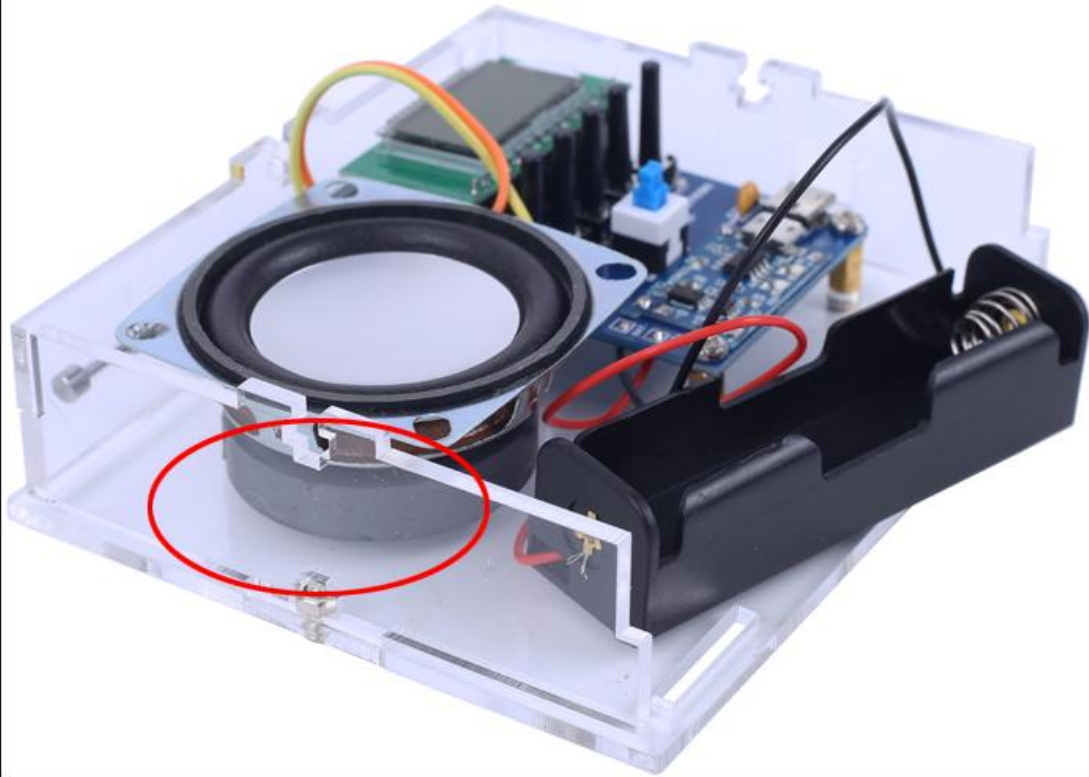

Step 28: Remove battery and fix 18650 Lithium Battery Box on another side acrylic plate by M3*6mm Screw and M3 Nut.

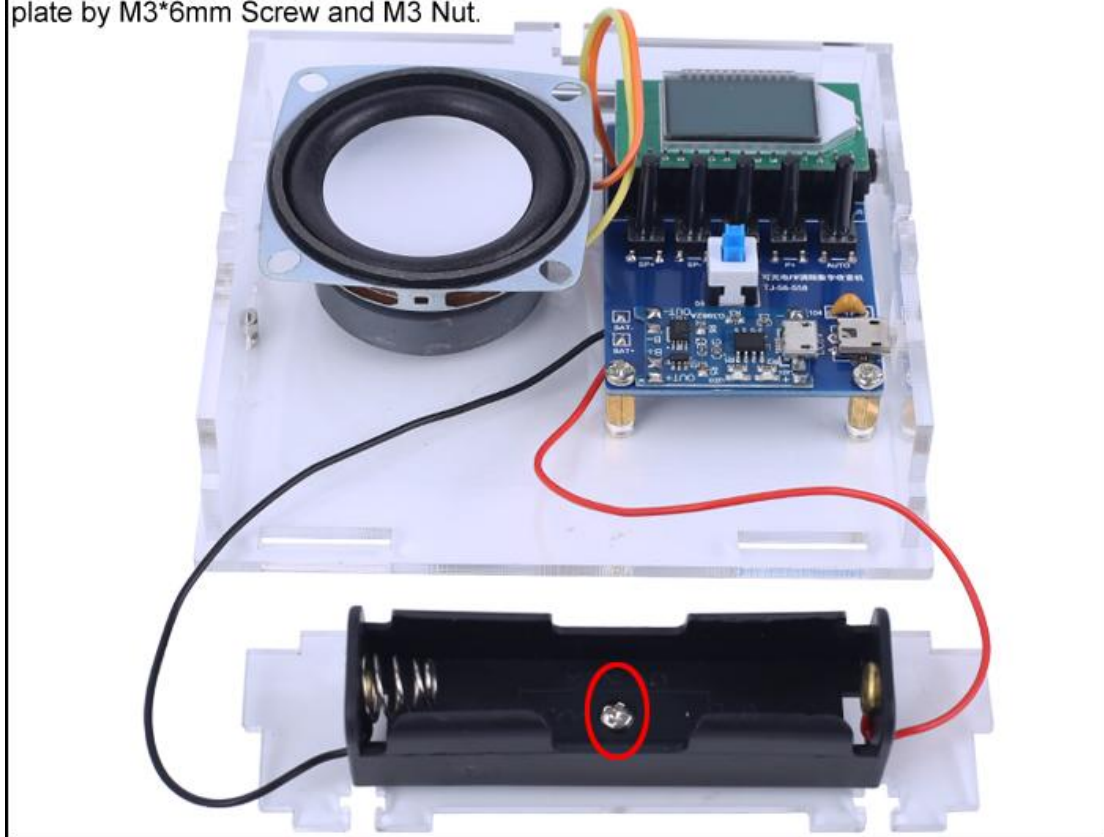

Step 29: Correctly install a rechargeable 18650 battery again. Pay attention to the positive and negative poles of the battery, otherwise it may damage the circuit board.

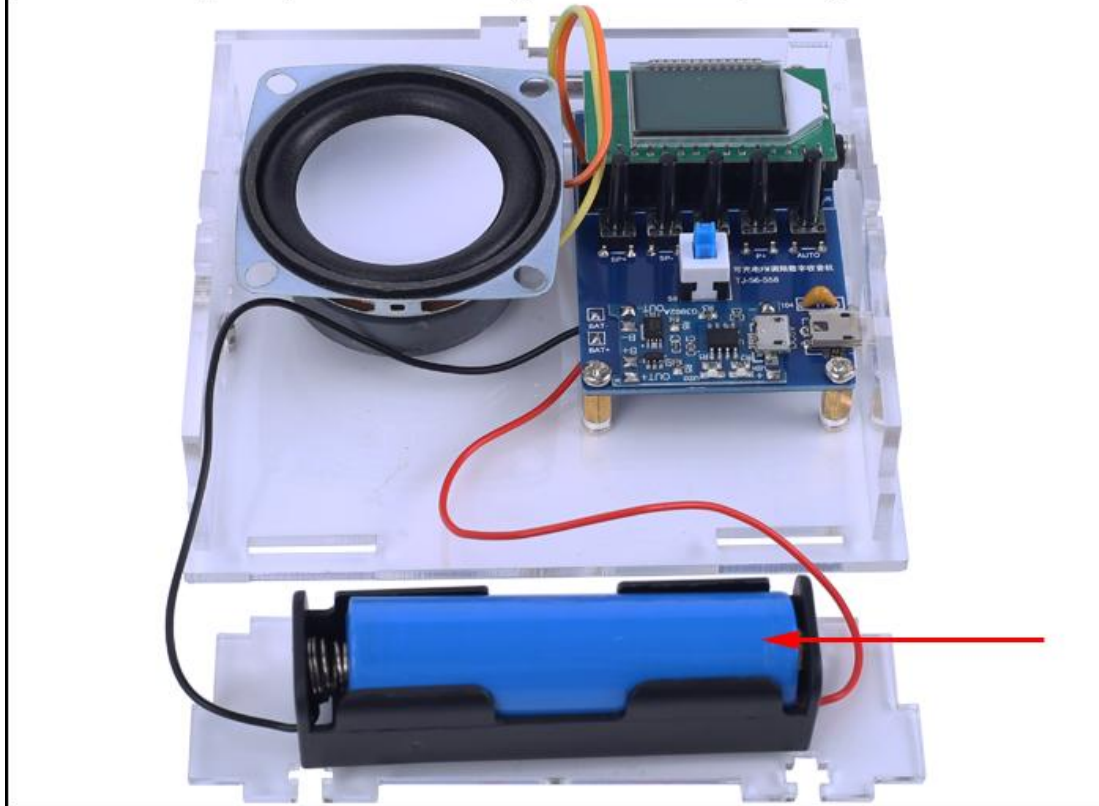

Step 30: Install the battery acrylic plate.

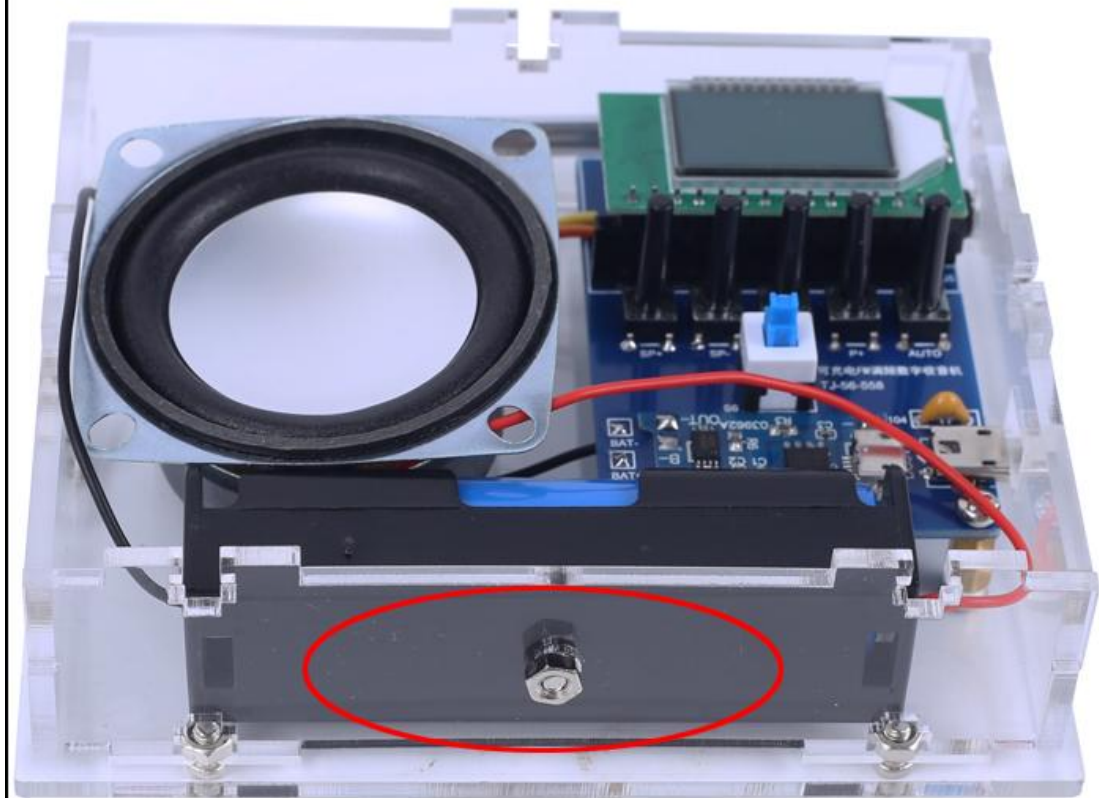

Step 31: Fix Speaker on the last acrylic plate by 4pcs M3*6mm Screw and M3 Nut.

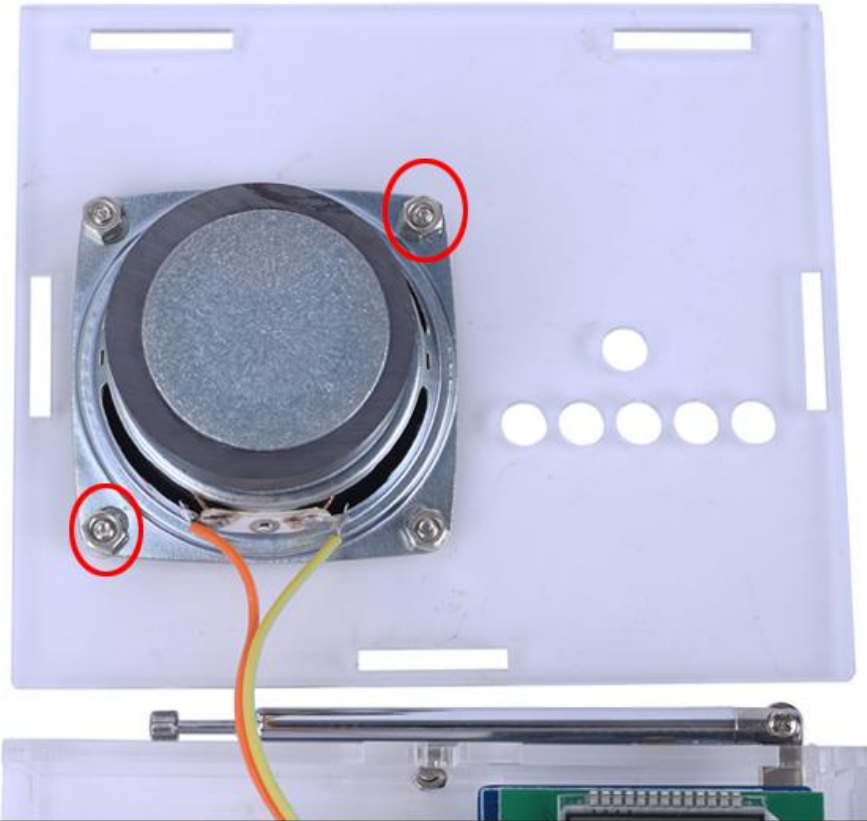

Step 32: Install the last acrylic plate and fix it with speaker by 4pcs M3*6mm Screw.



Step 33: Install button caps for black buttons and self-locking button.

